



**Metermatic**

**SCS-400**

**Sealed Parcel Delivery**  
**System**

**Configuration Manual**

## Table of Contents

1.	Entering Setup Mode .....	1
1.1.	System Setup .....	2
1.1.1.	Clock Setup .....	2
1.1.1.1.	Date .....	3
1.1.1.2.	Time .....	4
1.1.1.3.	Day of the week .....	5
1.1.1.4.	Time Zone .....	6
1.1.1.5.	Reset Date Time .....	7
1.1.2.	Memory Management .....	7
1.1.2.1.	Reset Event Log .....	8
1.1.2.2.	Reset Manager Pins .....	8
1.1.2.3.	Reset Seal Numbers .....	9
1.1.3.	Reset SCS System .....	9
1.2.	Facility Setup .....	10
1.2.1.	Vehicle Number .....	11
1.2.2.	Number of Compartments .....	13
1.2.3.	Number of API Sensors .....	14
1.2.4.	Number of Manhole Sensors .....	15
1.2.5.	Number of Bottom Valve Sensors .....	16
1.2.6.	Number of Remote IO Units .....	17
1.2.7.	Number of Retain sensors .....	18
1.2.8.	High Level Pin .....	19
1.3.	Peripherals Setup .....	20
1.3.1.	Reference Sensor Setup .....	21
1.3.2.	Manhole Sensor Setup .....	22
1.3.2.1.	Serial Number Setup .....	22
1.3.2.2.	Zero Manhole Sensor(s) .....	23
1.3.2.3.	Set Sensitivity .....	24
1.3.2.4.	Set Vibration Factor .....	25
1.3.2.5.	Debounce Time .....	26
1.3.2.6.	Reset Manhole Sensor(s) .....	26
1.3.3.	API Sensor Setup .....	27
1.3.3.1.	Serial Number Setup .....	27
1.3.3.2.	Calibrate API Sensor(s) .....	28
1.3.3.3.	Set Open Point .....	28
1.3.3.4.	API Drain Wait Time .....	29
1.3.3.5.	Reset API Sensor(s) .....	30
1.3.4.	Bottom Valve Sensor Setup .....	31
1.3.4.1.	Serial Number Setup .....	31
1.3.4.2.	Reset BV Sensor(s) .....	32
1.3.5.	Remote IO Setup .....	32
1.3.5.1.	Serial Number Setup .....	33

1.3.5.2.	Reset RIO(s) .....	34
1.3.6.	Proxy Setup .....	34
1.3.7.	Overfill Sensor Setup .....	34
1.4.	Operational Setup .....	35
1.4.1.	Input .....	36
1.4.2.	Output.....	36
1.4.3.	Optic Sensor .....	36
1.4.4.	No Seal Power off Time (min).....	36
1.4.5.	5 Wire Monitor.....	36
1.4.6.	Setup Products.....	37
1.4.7.	iButton Tags .....	37
1.4.8.	Display Orientation .....	38
1.4.9.	Inclination Sensor.....	38
1.5.	Test Routines .....	38
1.5.1.	Device Info.....	39
1.5.2.	IButton.....	40
1.5.3.	Remote IO .....	41
1.5.4.	IO.....	41
1.5.5.	5 Wire.....	41
1.5.6.	Disconnect Battery .....	42
1.5.7.	CAN Test .....	42
1.5.8.	Restart Ctrl Card .....	42
1.6.	Communication Setup .....	42
1.7.	Manager Pin Setup .....	44

## 1. Entering Setup Mode

With the SCS-400 is powered up, press the 'ENT' key on the keypad to go to the Main Menu. This is where the system setup is done.

The top display will change and ask for your PIN number.

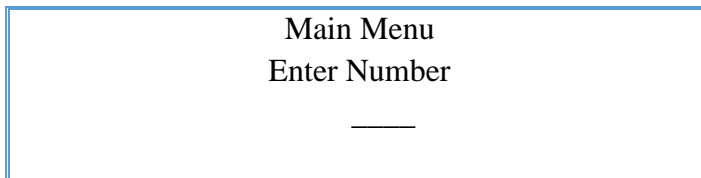

The default PIN is 8000. It is recommended that you change this PIN to protect the integrity of the system.

If you do not start entering your PIN within five seconds, the display will time out and revert to the Main Screen.

Enter your PIN and press the 'ENT' key. If the wrong PIN is entered, the display will simply revert to the Main Screen.

When the correct PIN has been entered, the Main Menu will be displayed:

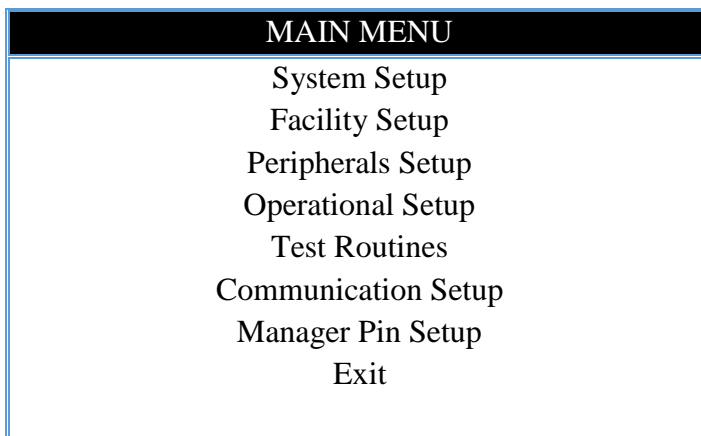

To go to a specific menu option, use the 'UP' or the 'DOWN' arrow (Keys 2 and 8 respectively) until the option you want is highlighted. Press the 'ENT' key to select the option.

**Note:**

The 'Exit' option will take you back to the previous menu. Using the 'Exit' option on the Main Menu will take you out of Setup. You can also use the 'LEFT' arrow (key 4) to move back to the previous menu, or exit out of Setup from the Main Menu.

Similarly, the 'RIGHT' arrow (key 6) can be used instead of using the 'ENT' key to select a highlighted option.

**1.1. System Setup**

The System Setup Menu has the following options:

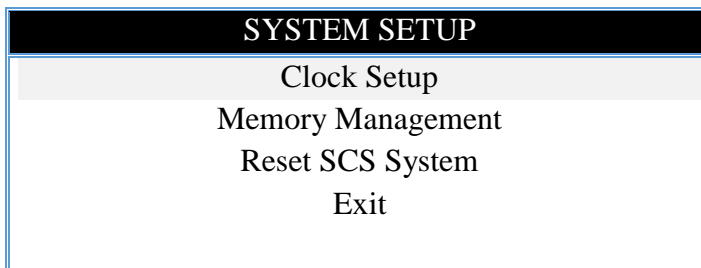
**1.1.1. Clock Setup**

The Clock Setup Menu has the following options:

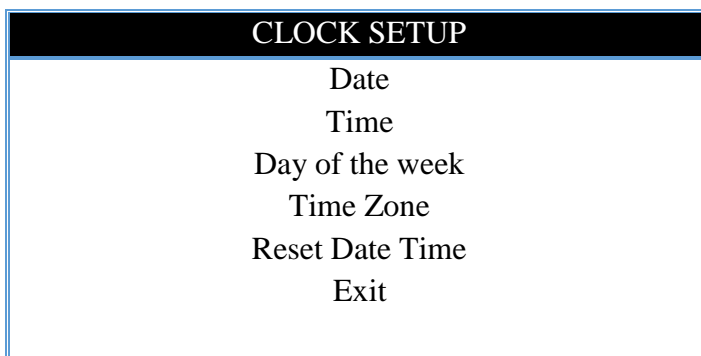

### 1.1.1.1. Date

When the 'Date' menu option is highlighted, the date set will be displayed at the bottom of the upper display:



Press 'ENT' to change the date:



Enter the date in the format shown:

dd = day

mm = month

cc = century

yy = year

Use the 'CLR' key to go back if you've made a mistake and the 'ENT' key when you've completed the entry.

### 1.1.1.2. Time

When the 'Time' menu option is highlighted, the time set will be displayed at the bottom of the upper display:

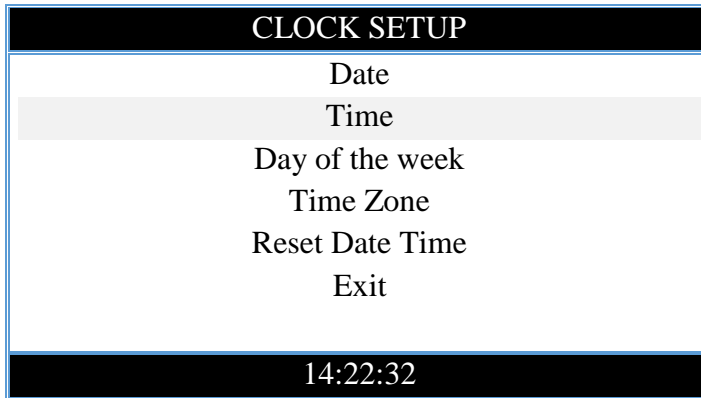

Press 'ENT' to change the time:

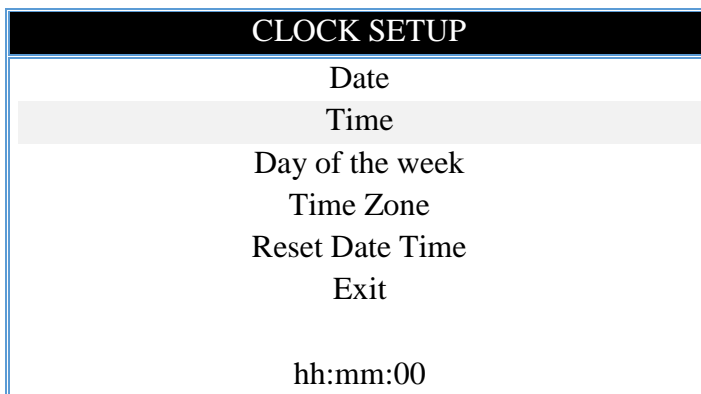

Enter the time in the format shown:

hh = hours

mm = minutes

Use the 'CLR' key to go back if you've made a mistake and the 'ENT' key when you've completed the entry.

### 1.1.1.3. Day of the week

When the 'Day of the week' menu option is highlighted, the day set will be displayed at the bottom of the upper display:

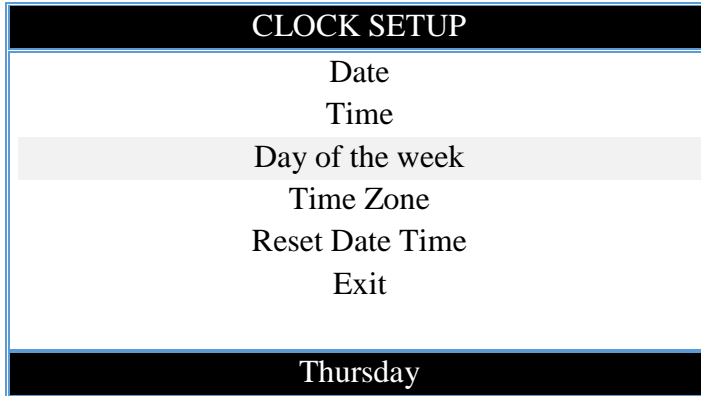

Press 'ENT' to change the day of the week:

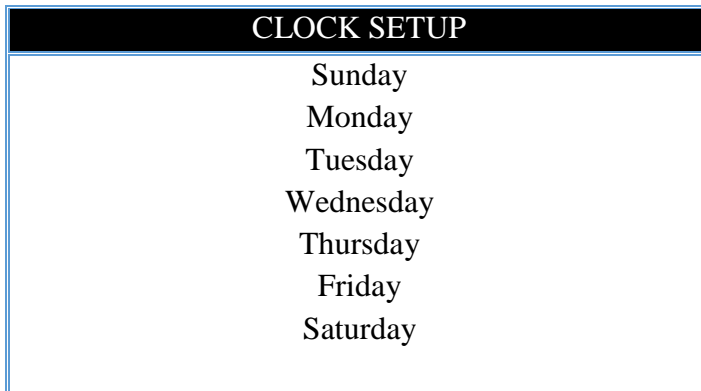

Select the day of the week from the list and press the 'ENT' key.



#### 1.1.1.4. Time Zone

When the 'Time Zone' menu option is highlighted, the time zone set will be displayed at the bottom of the upper display:

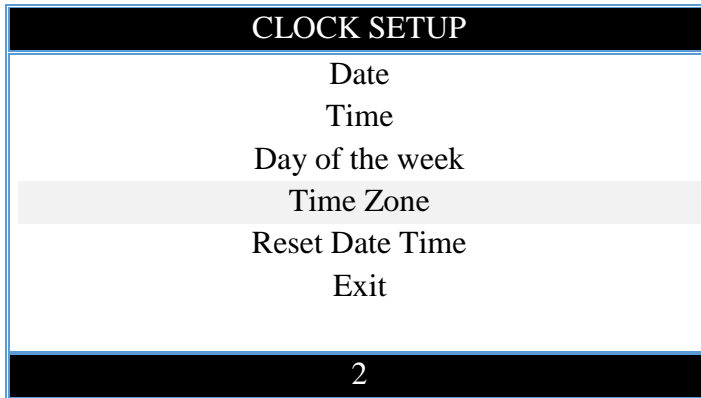

Press 'ENT' to change the time zone:



A message describing how to enter this value will be displayed on the bottom of the lower display:

'Push 1 for – and 2 for + first and then number!'

The Time Zone is relative to UTC (Coordinated Universal Time)

Examples: To enter UTC -2, press 1 and then 2. To enter UTC +2, press 2 and then 2 again. Press the 'ENT' key when you have completed the entry.

### 1.1.1.5. Reset Date Time

When the 'Reset Date Time' menu option is highlighted, the time and date set will be displayed at the bottom of the upper display:

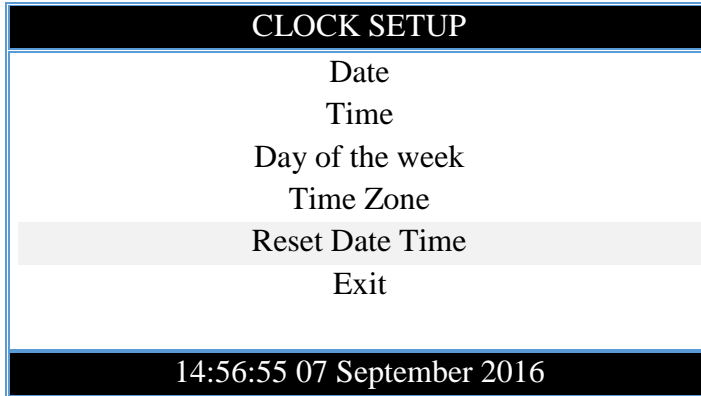

Press 'ENT' to reset the date and time:

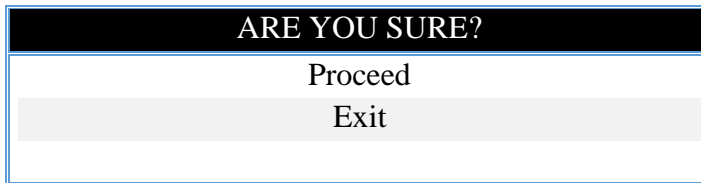

If you select 'Proceed' and press 'ENT', the date and time will be reset.

### 1.1.2. Memory Management

This is the second option on the System Setup Menu:

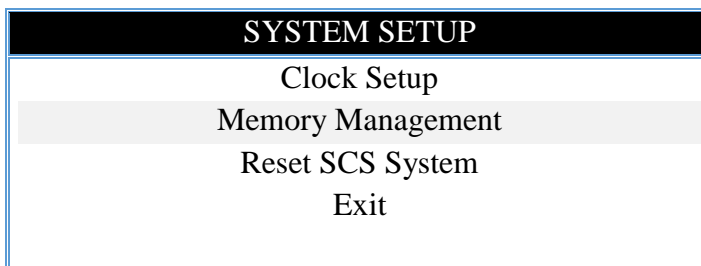

The Memory Management Menu has the following options:

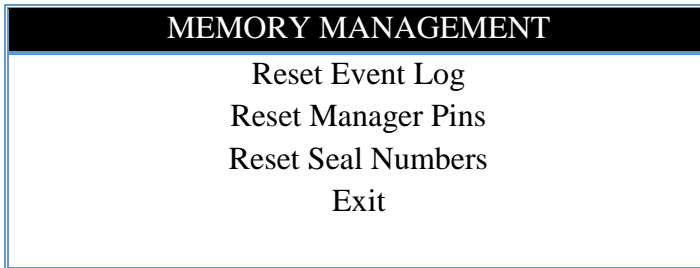

#### 1.1.2.1. Reset Event Log

With the 'Reset Event Log' menu option highlighted, pressing the 'ENT' key will bring up the confirmation display:

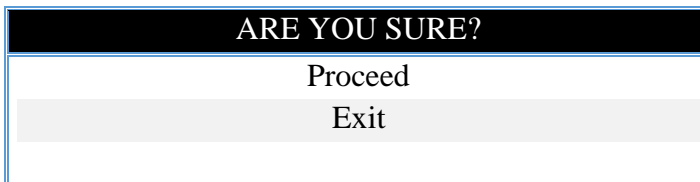

If you select 'Proceed' and press 'ENT', the event log will be reset. While the reset process is taking place, 'Resetting' will be shown on the bottom display. Once the process has been completed, the top display will return to the 'Memory Management' menu and the word 'Done!' will be displayed on the bottom display.

#### 1.1.2.2. Reset Manager Pins

With the 'Reset Manager Pins' menu option highlighted, pressing the 'ENT' key will bring up the confirmation display:

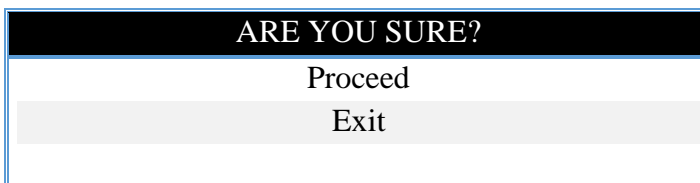

If you select 'Proceed' and press 'ENT', the manager pins will be reset.

### 1.1.2.3. Reset Seal Numbers

With the 'Reset Seal Numbers' menu option highlighted, pressing the 'ENT' key will bring up the confirmation display:

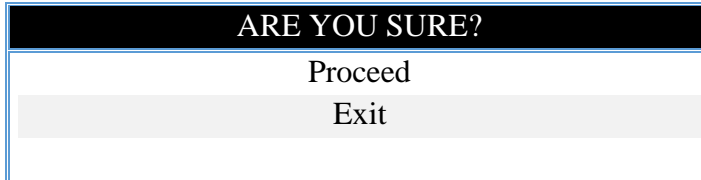

If you select 'Proceed' and press 'ENT', the Seal Numbers will be reset.

### 1.1.3. Reset SCS System

This is the third option on the System Setup Menu:

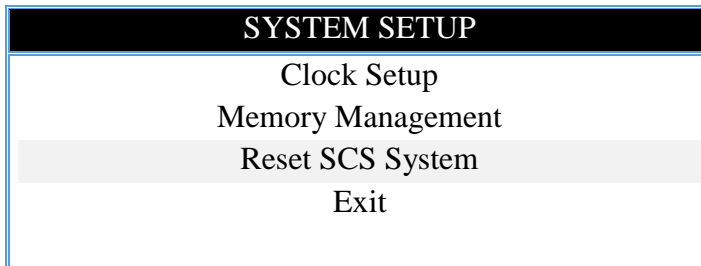

With the 'Reset SCS System' menu option highlighted, pressing the 'ENT' key will bring up the confirmation display:

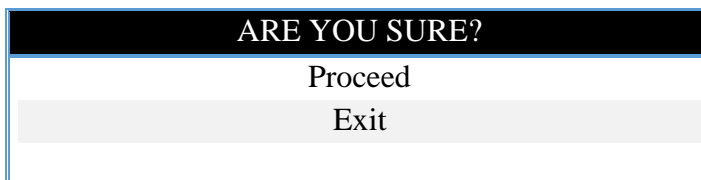

If you select 'Proceed' and press 'ENT', the SCS System will be reset. While the reset process is taking place, 'Resetting System. Please Wait...' will be shown on the bottom display. Once the process has been completed, the top display will return to the 'System Setup' menu and the word 'Done!' will be displayed on the bottom display.

## 1.2. Facility Setup

The 'Facility Setup' is the second option on the 'Main Menu':

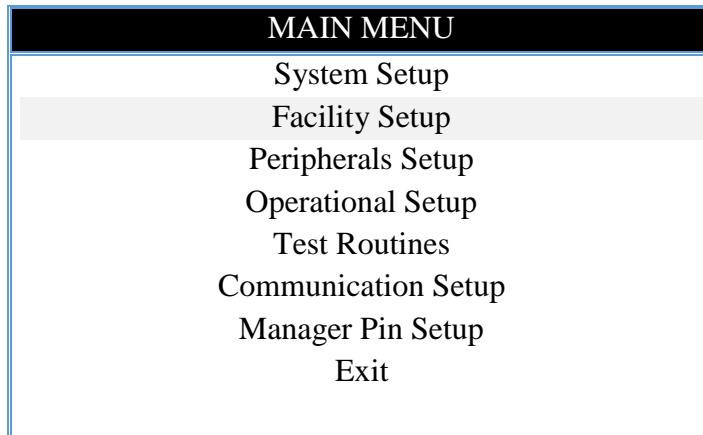

The 'Facility Setup' menu has the following options:

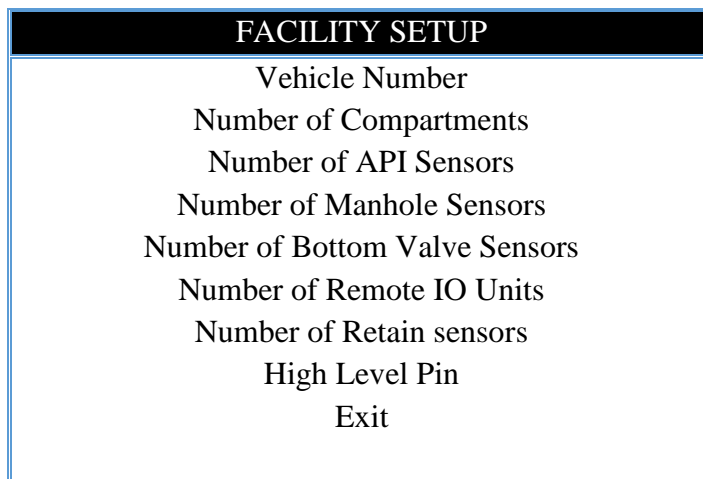

### 1.2.1. Vehicle Number

When the 'Vehicle Number' menu option is highlighted, the vehicle number set will be displayed at the bottom of the upper display:

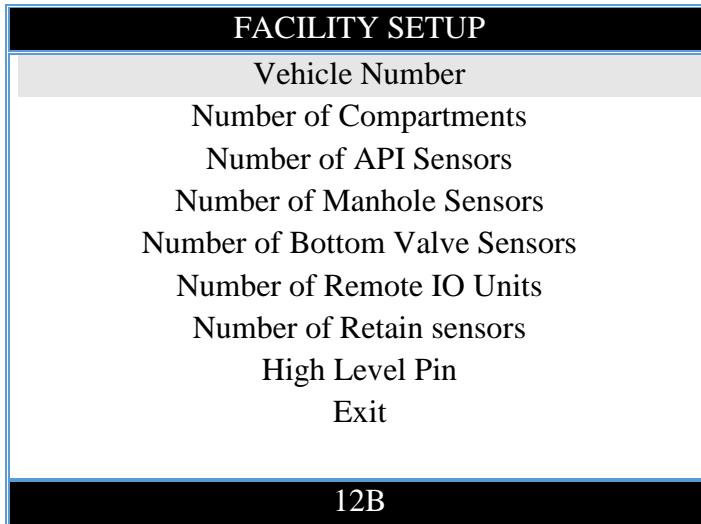

Press 'ENT' to change the vehicle number:

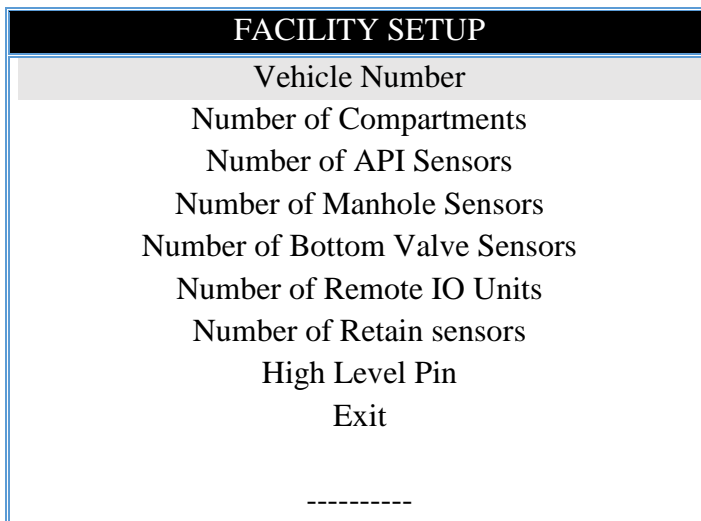

The Vehicle Number can be up to 10 alphanumeric characters long.

When you are on the vehicle edit display, the cursor will show under the character that will be changed. Use the 'RIGHT' and 'LEFT' arrows to move the cursor.

Characters are entered by first selecting the character set that you want to use. The '5' key is used for this. The first character set is Numeric. When you press the '5' key repeatedly, the characters sets available will be shown:

- '0' = Numeric
- 'A' = Uppercase letters
- 'a' = Lowercase letters
- ' ' (blank) = Special characters

When the required character set has been selected, use the 'UP' and 'DOWN' arrows to scroll through the characters until you reach the one you want to use.

Use the 'RIGHT' and 'LEFT' arrows to move the cursor to the next position and repeat the process.

**Example:**

To enter Vehicle Number Dz1#, use the following keystrokes:

<b>Key</b>	<b>Effect</b>
5 x 2	Selects the uppercase character set (A)
2 (UP arrow) x 3	Scrolls through the characters up to D
6 (RIGHT arrow)	Moves the cursor to the 2 <sup>nd</sup> position
5 x 2	Selects the lowercase character set (a)
8 (DOWN arrow)	Scrolls through the characters in the reverse order up to z
6 (RIGHT arrow)	Moves the cursor to the 3 <sup>rd</sup> position
2 (UP arrow)	Scrolls through the characters up to 1
6 (RIGHT arrow)	Moves the cursor to the 4 <sup>th</sup> position
5 x 3	Selects the special character set ( )
2 (UP arrow) x 3	Scrolls through the characters up to #

Press the 'ENT' key when you have completed the entry.

### 1.2.2. Number of Compartments

When the 'Number of Compartments' menu option is highlighted, the number of compartments set will be displayed at the bottom of the upper display:

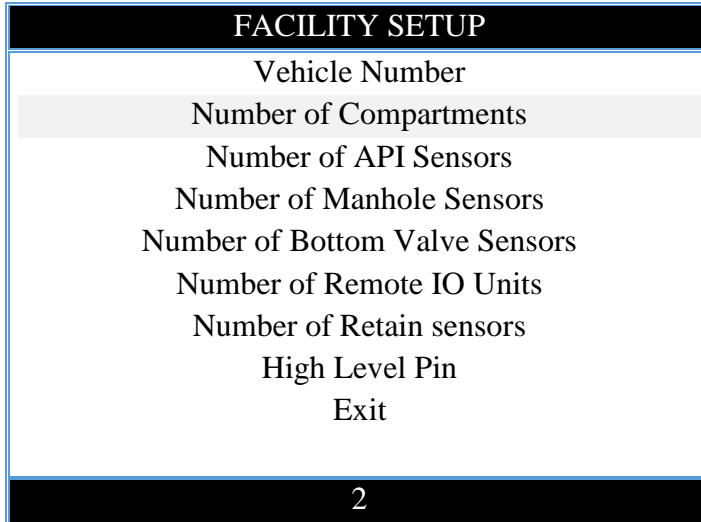

Press 'ENT' to change the number of compartments:

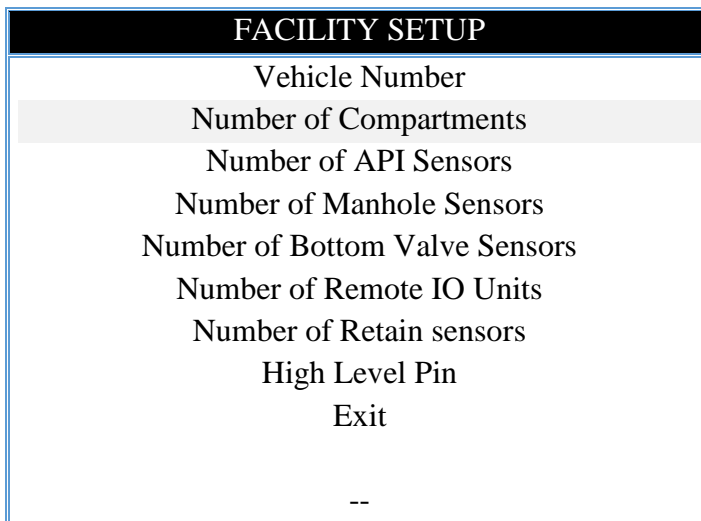

Enter the number of compartments and press the 'ENT' key when you have completed the entry.



### 1.2.3. Number of API Sensors

When the 'Number of API Sensors' menu option is highlighted, the number of API sensors set will be displayed at the bottom of the upper display:

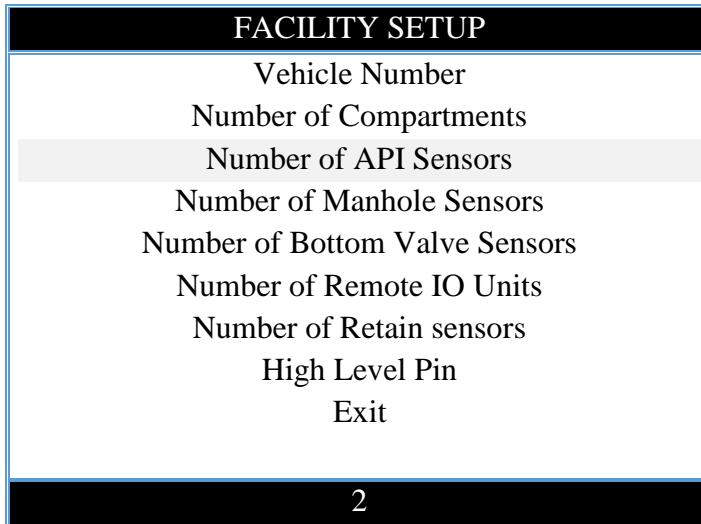

Press 'ENT' to change the number of API sensors:

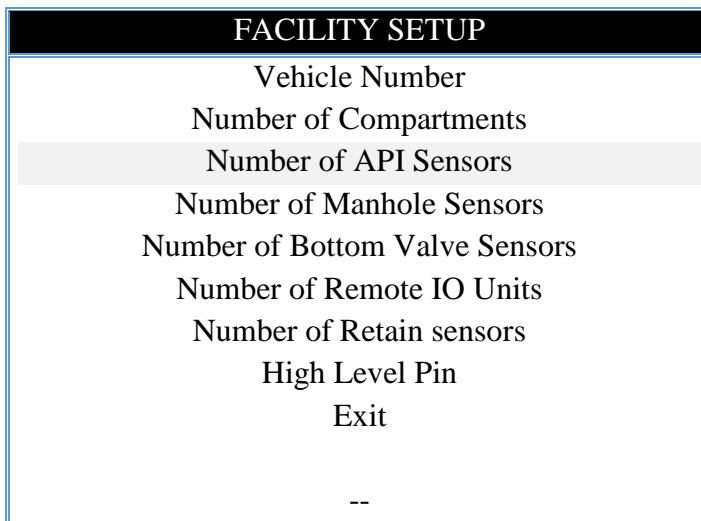

Enter the number of API sensors and press the 'ENT' key when you have completed the entry.

#### 1.2.4. Number of Manhole Sensors

When the 'Number of Manhole Sensors' menu option is highlighted, the number of manhole sensors set will be displayed at the bottom of the upper display:

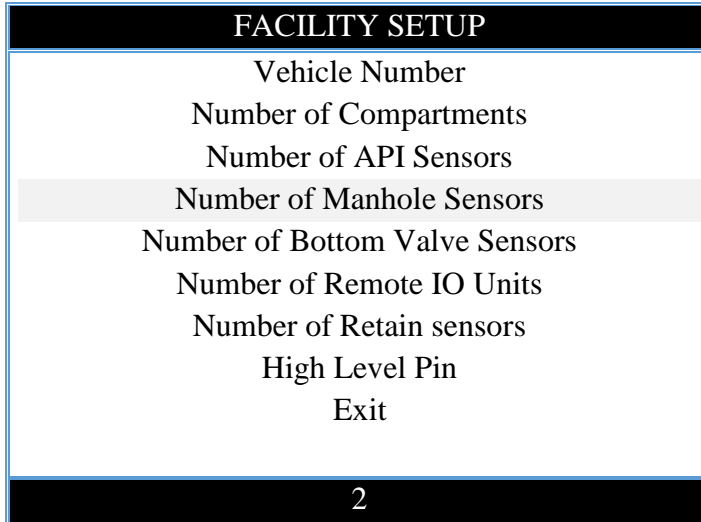

Press 'ENT' to change the number of manhole sensors:

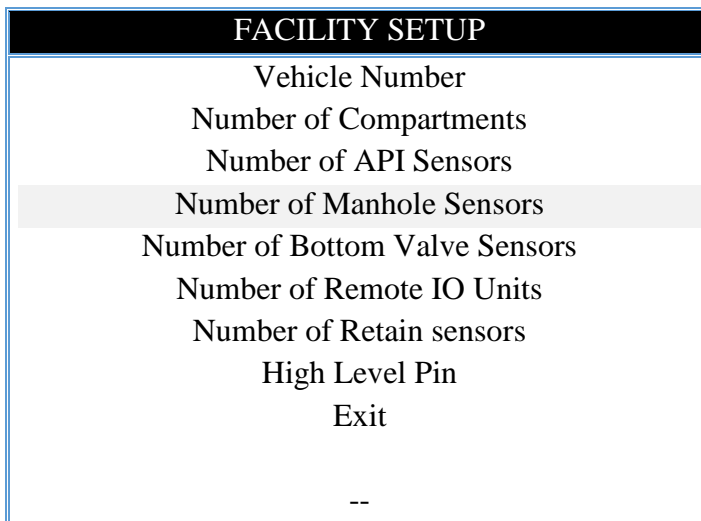

Enter the number of manhole sensors and press the 'ENT' key when you have completed the entry.

### 1.2.5. Number of Bottom Valve Sensors

When the 'Number of Bottom Valve Sensors' menu option is highlighted, the number of bottom valve sensors set will be displayed at the bottom of the upper display:

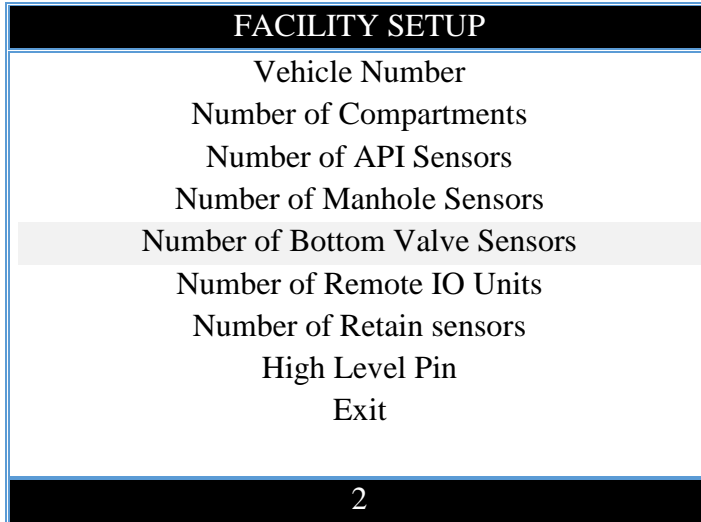

Press 'ENT' to change the number of bottom valve sensors:

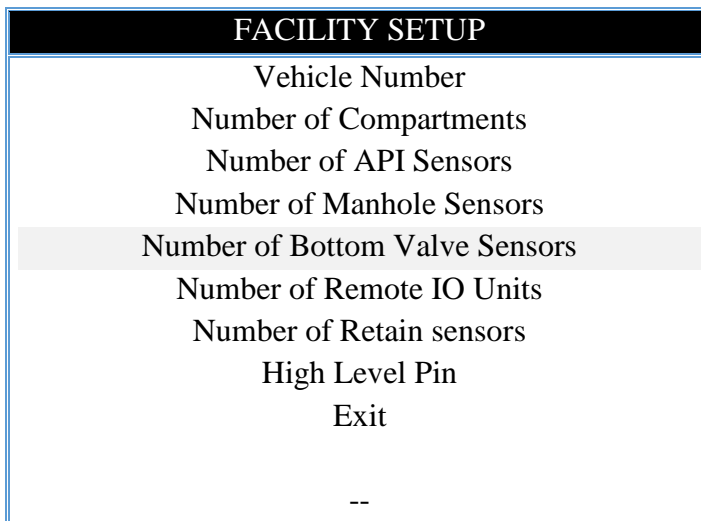

Enter the number of bottom valve sensors and press the 'ENT' key when you have completed the entry.

### 1.2.6. Number of Remote IO Units

When the 'Number of Remote IO Units' menu option is highlighted, the number of remote IO units set will be displayed at the bottom of the upper display:

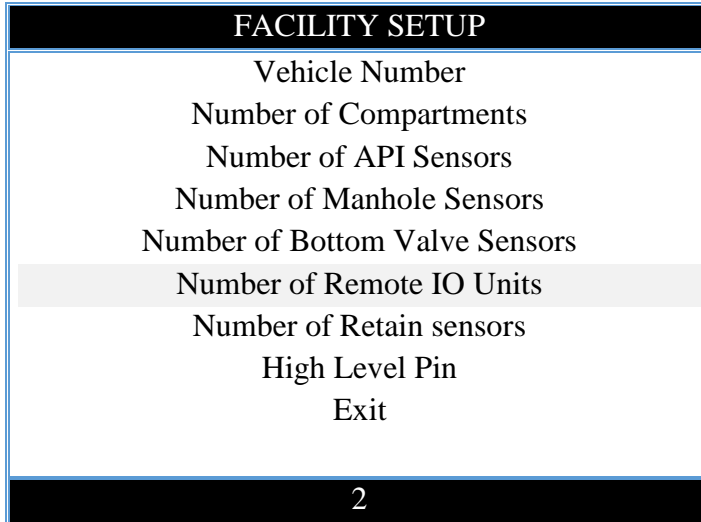

Press 'ENT' to change the number of remote IO units:

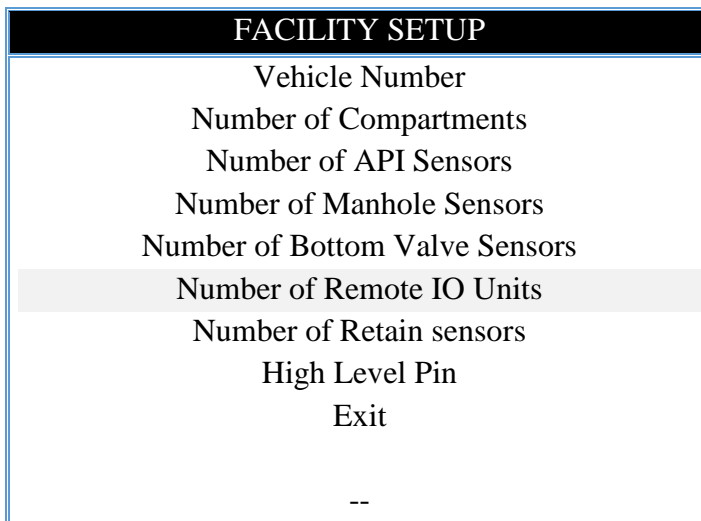

Enter the number of remote IO units and press the 'ENT' key when you have completed the entry.

### 1.2.7. Number of Retain sensors

When the 'Number of Retain sensors' menu option is highlighted, the number of retain sensors set will be displayed at the bottom of the upper display:

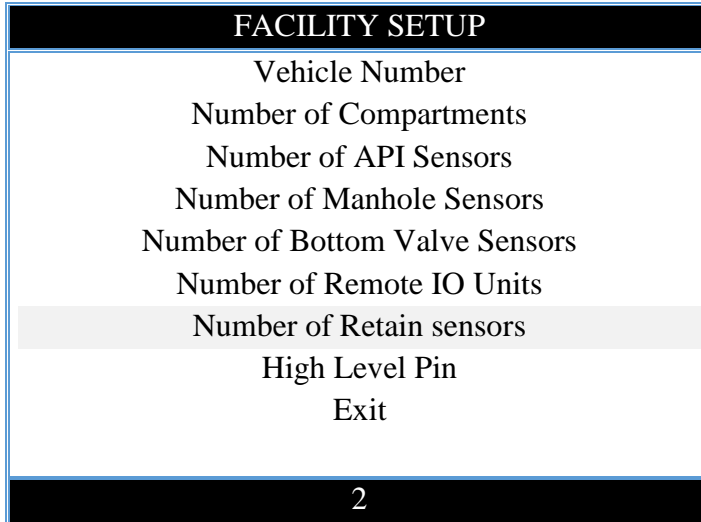

Press 'ENT' to change the number of retain sensors:

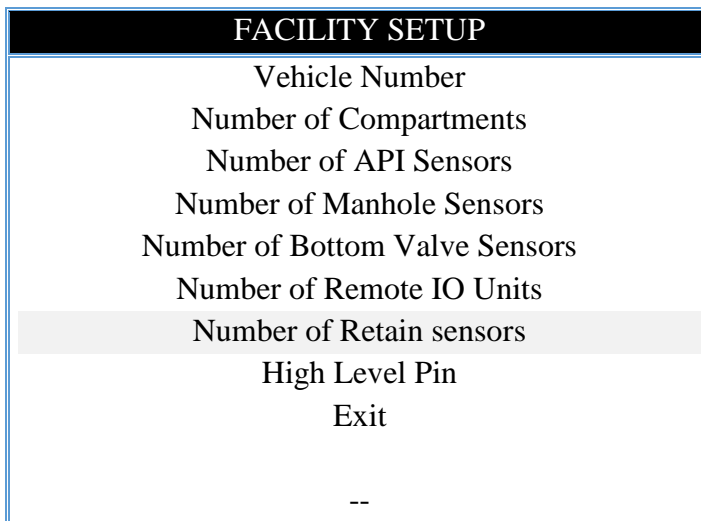

Enter the number of retain sensors and press the 'ENT' key when you have completed the entry.

### 1.2.8. High Level Pin

When the 'High Level Pin' menu option is highlighted, the high level PIN set will be displayed at the bottom of the upper display:

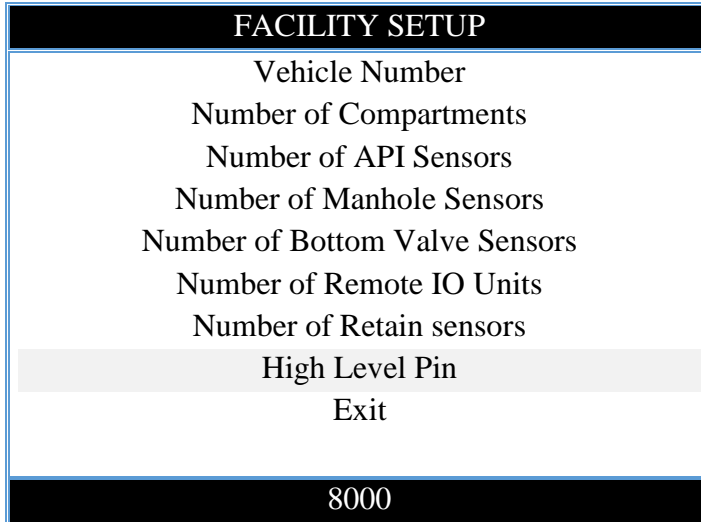

Press 'ENT' to change the high level PIN:

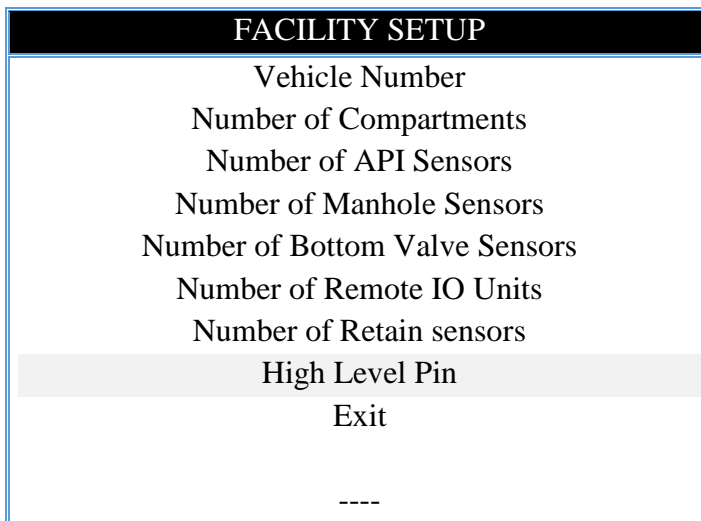

Enter the high level PIN (4 Digits) and press the 'ENT' key when you have completed the entry.

### 1.3. Peripherals Setup

The 'Peripherals Setup' is the third option on the 'Main Menu':

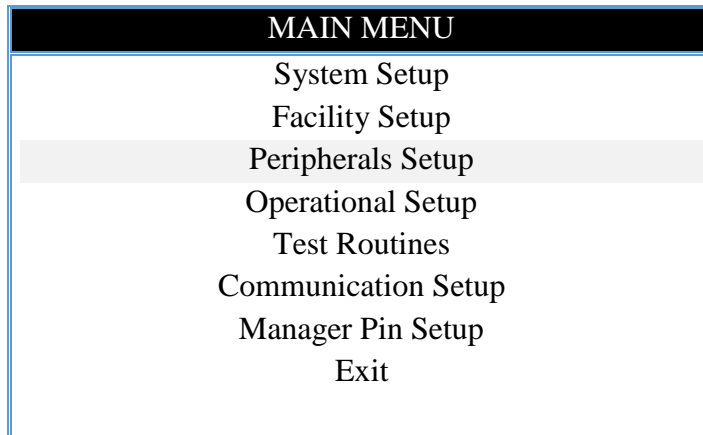

The 'Peripheral Setup' menu has the following options:

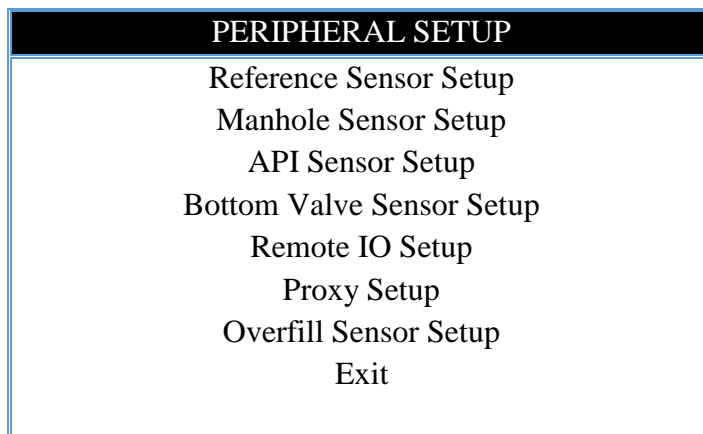

### 1.3.1. Reference Sensor Setup

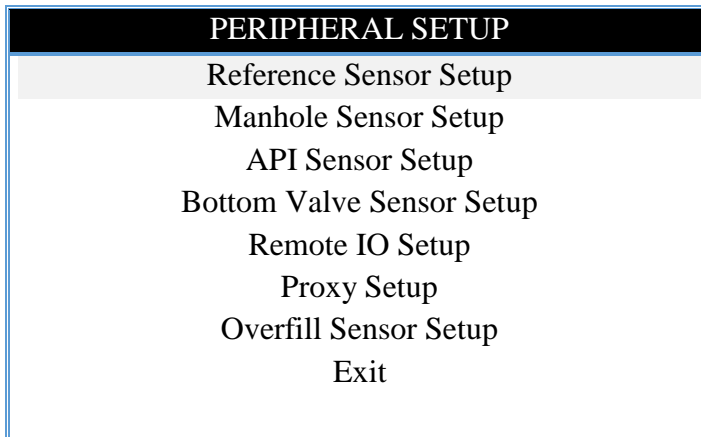

When the 'Reference Sensor Setup' option is selected, the 'Reference Sensor Setup' menu is displayed:

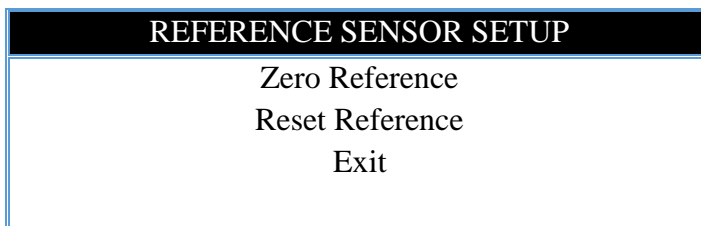

When the 'Zero Reference' menu option is highlighted, either NOT Zeroed or Zeroed will be displayed at the bottom of the upper display:

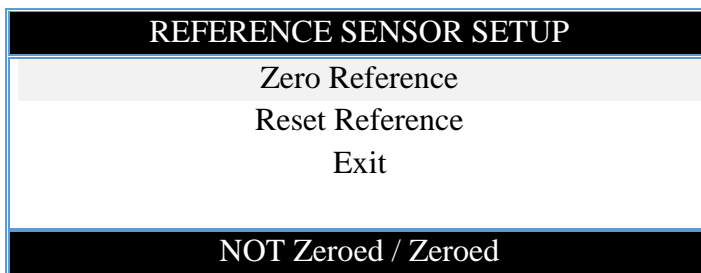

The reference sensor has to be zeroed for the system to operate properly. If the reference is 'NOT Zeroed', select the 'Zero Reference' option and press 'ENT'. A message 'Please wait' will appear on the bottom display until the process has been completed. If the reference sensor has been zeroed, but needs to be zeroed again (e.g. the installation was moved, or a new sensor fitted), first 'Reset Reference' and then 'Zero Reference'.



### 1.3.2. Manhole Sensor Setup

When the 'Manhole Sensor Setup' option is selected, the 'Manhole Sensor Setup' menu is displayed:

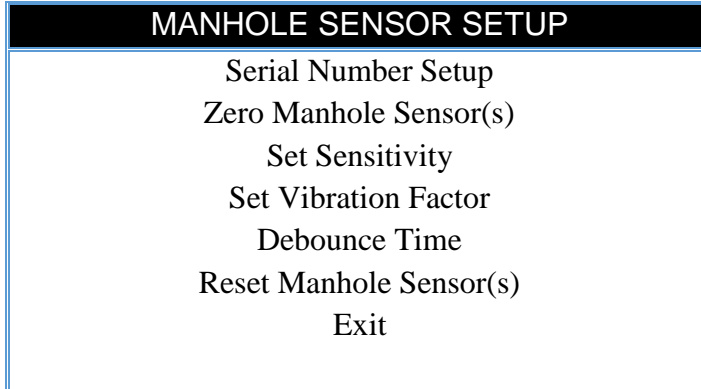

#### 1.3.2.1. Serial Number Setup

When the 'Serial Number Setup' option is selected, the 'Manhole Sensor Info' will be displayed:

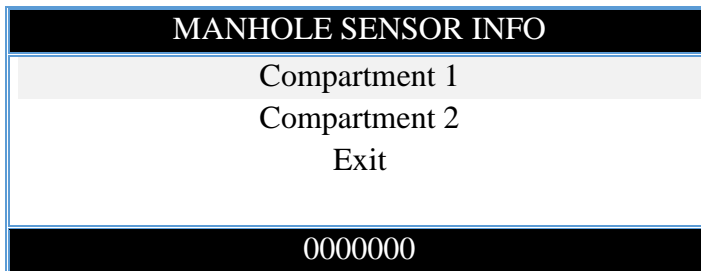

The number of compartments shown will depend on what was configured in the Facility Setup section. When a specific compartment is highlighted, the serial number of the manhole sensor that has been configured for that compartment will be shown at the bottom of the screen.

Select a compartment by pressing ‘ENT’ when the compartment is highlighted. This will display a list of serial numbers for all the manhole sensors detected by the system that have not yet been allocated to a specific compartment:

MANHOLE SENSOR INFO
1511098
1511094
Exit

Select the serial number of the sensor that has been installed on the compartment and press ‘ENT’. Repeat the process for each compartment.

### 1.3.2.2. Zero Manhole Sensor(s)

When the ‘Zero Manhole Sensor(s)’ option is selected, the ‘Manhole Sensor Zeroing’ menu will be displayed:

MANHOLE SENSOR ZEROING
Compartment 1
Compartment 2
ALL
Exit
NOT Zeroed / Zeroed

The number of compartments shown will depend on what was configured in the Facility Setup section. When a specific compartment is highlighted, the zeroed status of the manhole sensor of that compartment will be shown at the bottom of the screen.

Select a compartment by pressing ‘ENT’ when the compartment is highlighted. This will zero the manhole sensor for that compartment. All manhole sensors can be zeroed at the same time by selecting the appropriate option.

A status message will be shown on the bottom display while the zeroing process is taking place.

### 1.3.2.3. Set Sensitivity

When the 'Set Sensitivity' option is selected, the 'Manhole Sensitivity Setup' menu will be displayed:

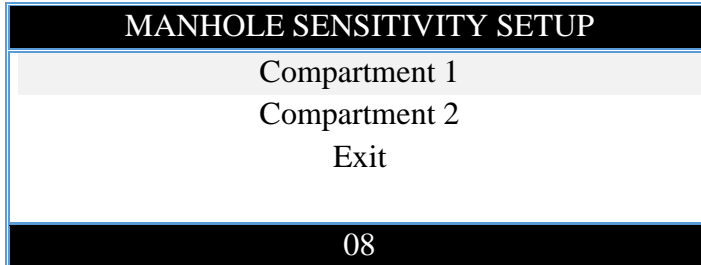

The number of compartments shown will depend on what was configured in the Facility Setup section. When a specific compartment is highlighted, the sensitivity setting of the manhole sensor of that compartment will be shown at the bottom of the screen.

Select a compartment by pressing 'ENT' when the compartment is highlighted.

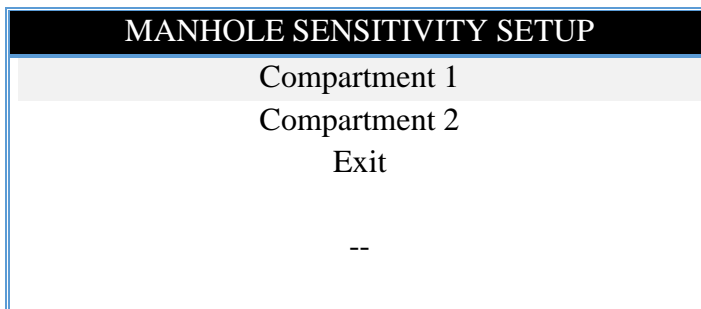

Enter the sensitivity (6 = Most and 15 = Least) for the manhole sensor and press the 'ENT' key when you have completed the entry.

Repeat the process for each compartment.

#### 1.3.2.4. Set Vibration Factor

When the 'Set Vibration Factor' option is selected, the 'Manhole Vibration Setup' menu will be displayed:



The number of compartments shown will depend on what was configured in the Facility Setup section. When a specific compartment is highlighted, the vibration setting of the manhole sensor of that compartment will be shown at the bottom of the screen.

Select a compartment by pressing 'ENT' when the compartment is highlighted.

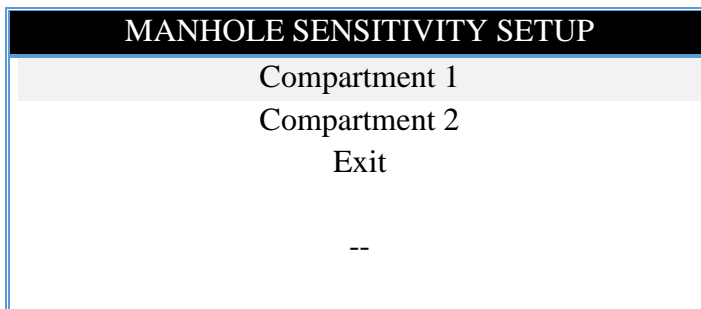

Enter the vibration factor (5 = Most and 25 = Least) for the manhole sensor and press the 'ENT' key when you have completed the entry.

Repeat the process for each compartment.

### 1.3.2.5. Debounce Time

When the ‘Debounce Time’ menu option is highlighted, the debounce time set will be displayed at the bottom of the upper display:

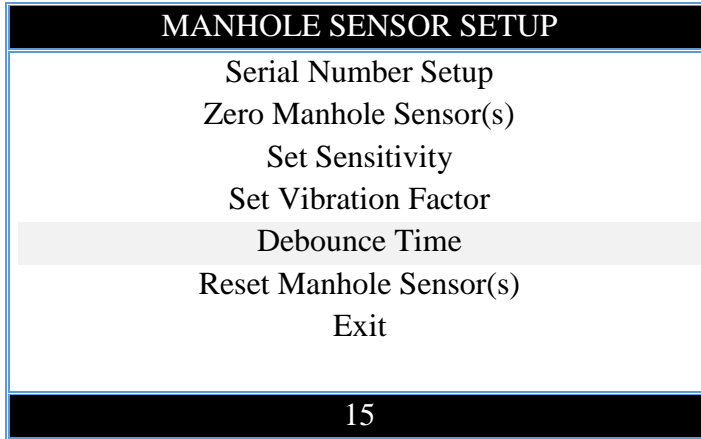

The debounce time is common to all manhole sensors. Press ‘ENT’ to change the debounce time. Enter the debounce time (5 = Most and 25 = Least) for the manhole sensor and press the ‘ENT’ key when you have completed the entry.

### 1.3.2.6. Reset Manhole Sensor(s)

When the ‘Reset Manhole Sensor(s)’ option is selected, the ‘Reset Manhole Sensors’ menu will be displayed:

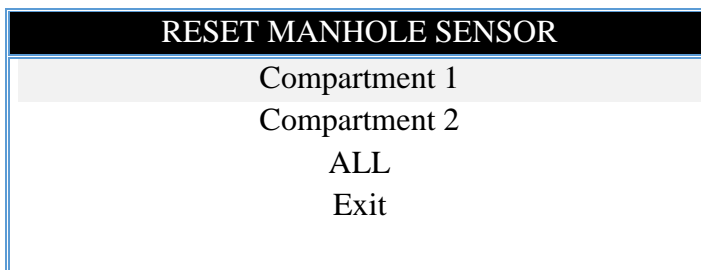

The number of compartments shown will depend on what was configured in the Facility Setup section.

Select a compartment by pressing ‘ENT’ when the compartment is highlighted. This will reset the manhole sensor for that compartment. All manhole sensors can be reset at the same time by selecting the appropriate option.

A status message will be shown on the bottom display while the reset process is taking place.

### 1.3.3. API Sensor Setup

When the 'API Sensor Setup' option is selected, the 'API Sensor Setup' menu is displayed:

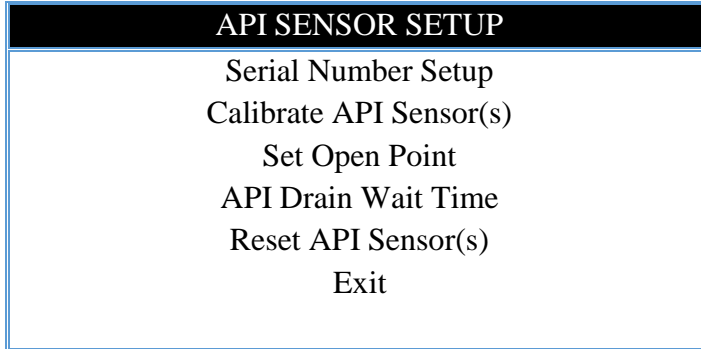

#### 1.3.3.1. Serial Number Setup

When the 'Serial Number Setup' option is selected, the 'API Sensor Setup' will be displayed:

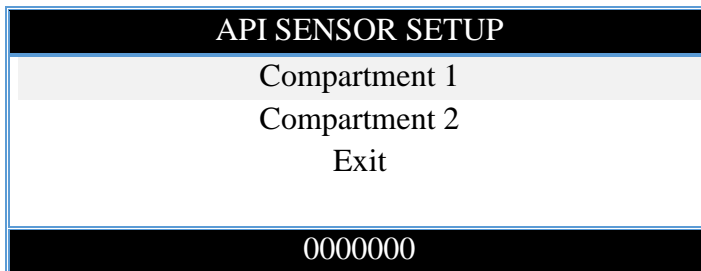

The number of compartments shown will depend on what was configured in the Facility Setup section. When a specific compartment is highlighted, the serial number of the API sensor that has been configured for that compartment will be shown at the bottom of the screen.

Select a compartment by pressing 'ENT' when the compartment is highlighted. This will display a list of serial numbers for all the API sensors detected by the system that have not yet been allocated to a specific compartment:

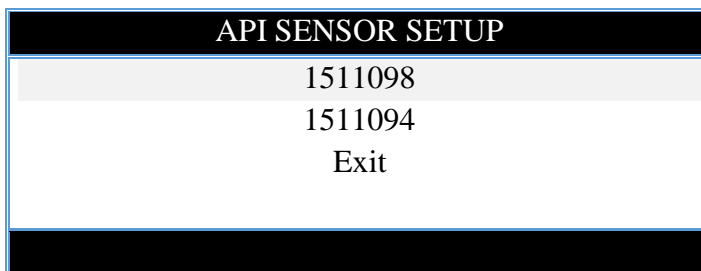

Select the serial number of the sensor that has been installed on the compartment and press 'ENT'. Repeat the process for each compartment.

### 1.3.3.2. Calibrate API Sensor(s)

When the 'Calibrate API Sensor(s)' option is selected, the 'API Calibration' menu will be displayed:

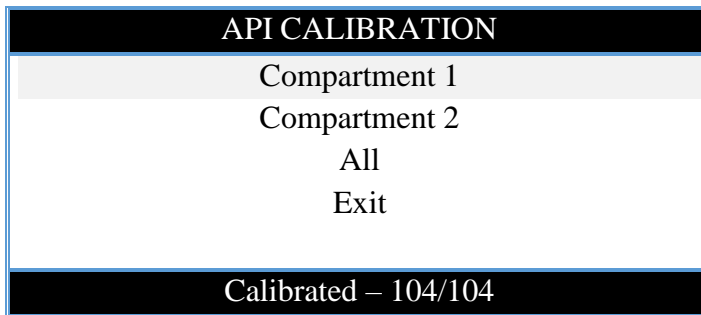

The number of compartments shown will depend on what was configured in the Facility Setup section. When a specific compartment is highlighted, the calibration status of the API sensor that has been configured for that compartment will be shown at the bottom of the screen

Select a compartment by pressing 'ENT' when the compartment is highlighted. This will calibrate the API sensor for that compartment. All API sensors can be calibrated at the same time by selecting the appropriate option.

A status message will be shown on the bottom display while the calibration process is taking place.

### 1.3.3.3. Set Open Point

When the 'Set Open Point' option is selected, the 'API Open Point' menu will be displayed:

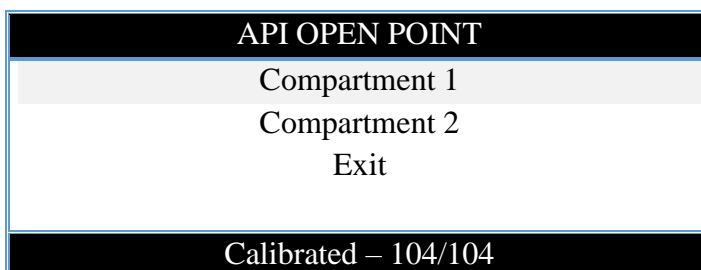

The number of compartments shown will depend on what was configured in the Facility Setup section. When a specific compartment is highlighted, the calibration status of the API sensor that has been configured for that compartment will be shown at the bottom of the screen

Select a compartment by pressing 'ENT' when the compartment is highlighted.

API OPEN POINT
Compartment 1
Compartment 2
Exit
---

Enter the open point (1 = Least and 255 = Most) for the API sensor and press the 'ENT' key when you have completed the entry.

Repeat the process for each compartment.

#### 1.3.3.4. API Drain Wait Time

When the 'Set Open Point' option is selected, the 'API Open Point' menu will be displayed:

API WAIT TIME
Compartment 1
Compartment 2
Exit
30

The number of compartments shown will depend on what was configured in the Facility Setup section. When a specific compartment is highlighted, the wait time set for the API sensor that has been configured for that compartment will be shown at the bottom of the screen



Select a compartment by pressing ‘ENT’ when the compartment is highlighted.

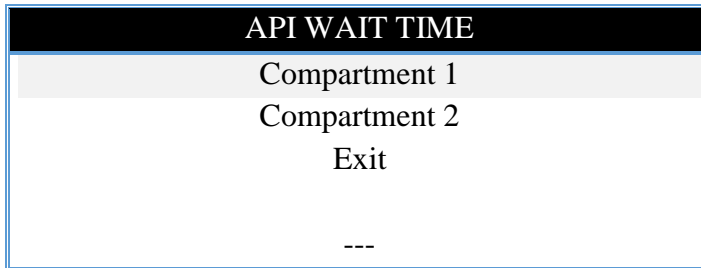

Enter the wait time for the API sensor and press the ‘ENT’ key when you have completed the entry.

Repeat the process for each compartment.

### 1.3.3.5. Reset API Sensor(s)

When the ‘Reset API Sensor(s)’ option is selected, the ‘Reset API Sensor(s)’ menu will be displayed:

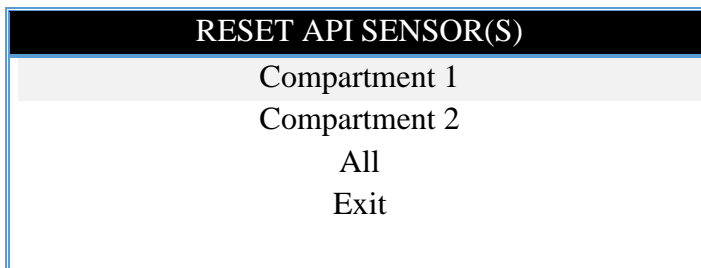

The number of compartments shown will depend on what was configured in the Facility Setup section.

Select a compartment by pressing ‘ENT’ when the compartment is highlighted. This will reset the API sensor for that compartment. All API sensors can be reset at the same time by selecting the appropriate option.

A status message will be shown on the bottom display while the reset process is taking place.

### 1.3.4. Bottom Valve Sensor Setup

When the 'Bottom Valve Sensor Setup' option is selected, the 'BV Sensor Setup' menu is displayed:

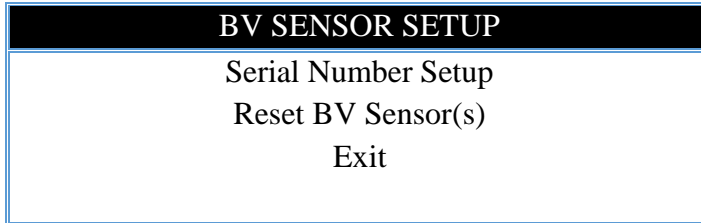

#### 1.3.4.1. Serial Number Setup

When the 'Serial Number Setup' option is selected, the 'BV Sensor Setup' will be displayed:

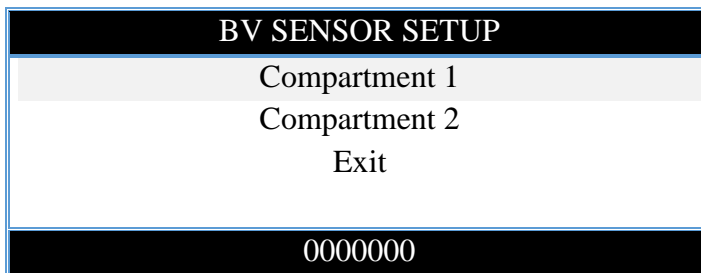

The number of compartments shown will depend on what was configured in the Facility Setup section. When a specific compartment is highlighted, the serial number of the BV sensor that has been configured for that compartment will be shown at the bottom of the screen.

Select a compartment by pressing 'ENT' when the compartment is highlighted. This will display a list of serial numbers for all the BV sensors detected by the system that have not yet been allocated to a specific compartment:

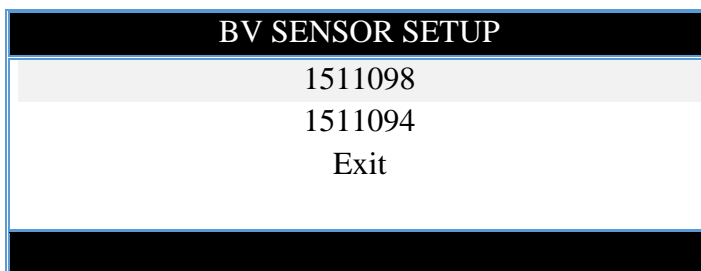

Select the serial number of the sensor that has been installed on the compartment and press 'ENT'. Repeat the process for each compartment.

### 1.3.4.2. Reset BV Sensor(s)

When the 'Reset API Sensor(s)' option is selected, the 'Reset API Sensor(s)' menu will be displayed:

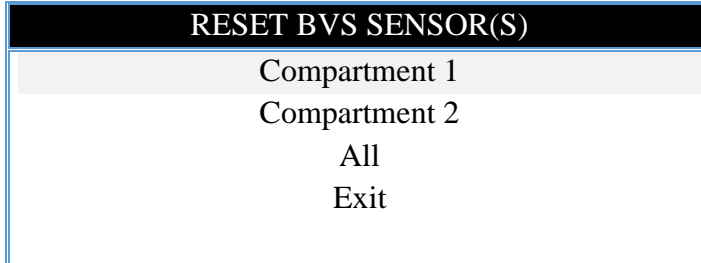

The number of compartments shown will depend on what was configured in the Facility Setup section.

Select a compartment by pressing 'ENT' when the compartment is highlighted. This will reset the BV sensor for that compartment. All BV sensors can be reset at the same time by selecting the appropriate option.

A status message will be shown on the bottom display while the reset process is taking place.

### 1.3.5. Remote IO Setup

When the 'Bottom Valve Sensor Setup' option is selected, the 'BV Sensor Setup' menu is displayed:

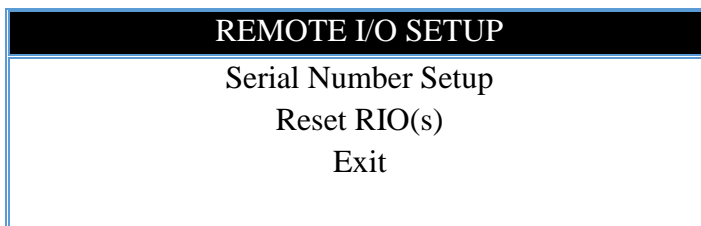

### 1.3.5.1. Serial Number Setup

When the 'Serial Number Setup' option is selected, the 'Remote I/O Setup' will be displayed:

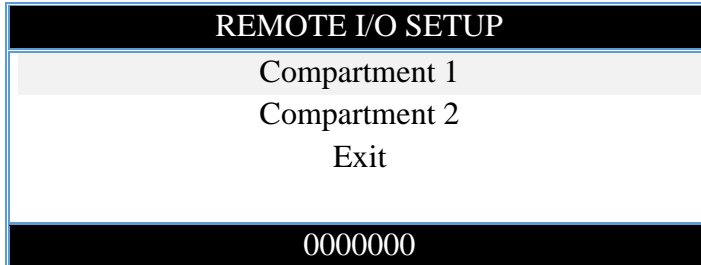

The number of compartments shown will depend on what was configured in the Facility Setup section. When a specific compartment is highlighted, the serial number of the remote I/O sensor that has been configured for that compartment will be shown at the bottom of the screen.

Select a compartment by pressing 'ENT' when the compartment is highlighted. This will display a list of serial numbers for all the remote I/O sensors detected by the system that have not yet been allocated to a specific compartment:

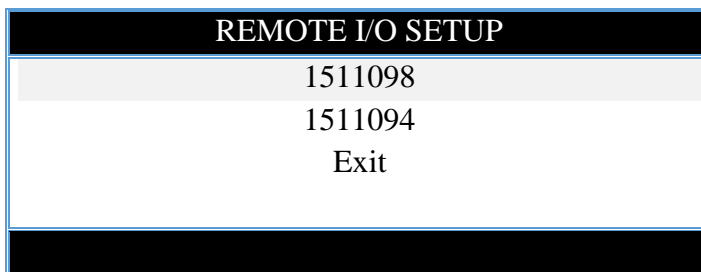

Select the serial number of the sensor that has been installed on the compartment and press 'ENT'. Repeat the process for each compartment.

### 1.3.5.2. Reset RIO(s)

When the 'Reset RIO(s)' option is selected, the 'Remote I/O Reset' menu will be displayed:

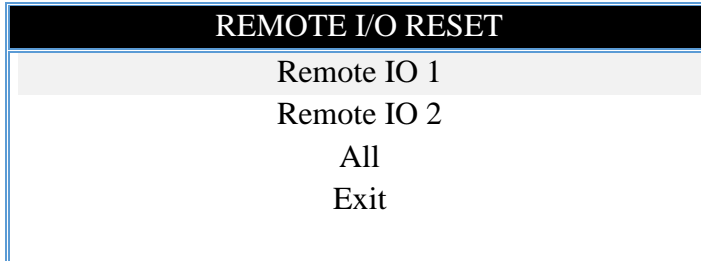

The number of compartments shown will depend on what was configured in the Facility Setup section.

Select a compartment by pressing 'ENT' when the compartment is highlighted. This will reset the IO sensor for that compartment. All IO sensors can be reset at the same time by selecting the appropriate option.

A status message will be shown on the bottom display while the reset process is taking place.

### 1.3.6. Proxy Setup

When the 'Proxy Setup' option is selected, the 'Proxy Setup' menu is displayed:

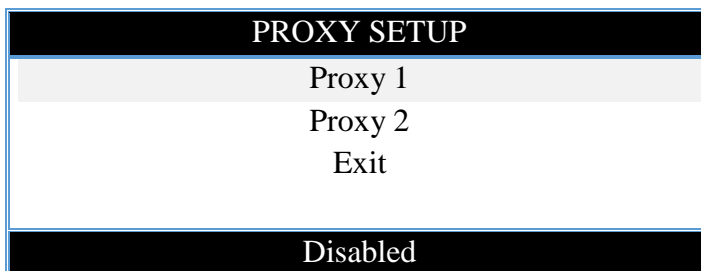

When a specific proxy is highlighted, the status of the proxy will be shown at the bottom of the screen.

Select a proxy by pressing 'ENT' when the proxy is highlighted. This will allow you to Enable or Disable the specific proxy.

### 1.3.7. Overfill Sensor Setup

When the 'Overfill Sensor Setup' option is selected, the 'Overfill Sensor Setup' menu is displayed:

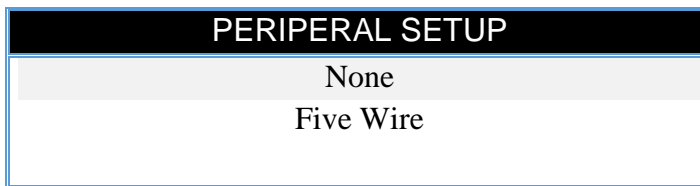

Select the required option by pressing 'ENT' when the proxy is highlighted.

#### 1.4. Operational Setup

The 'Operational Setup' is the fourth option on the 'Main Menu':

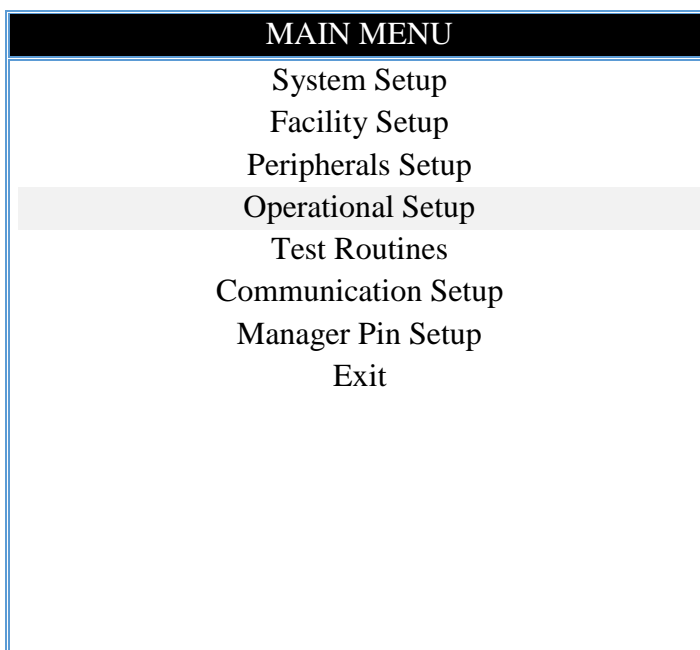

The 'Operational Setup' menu has the following options:

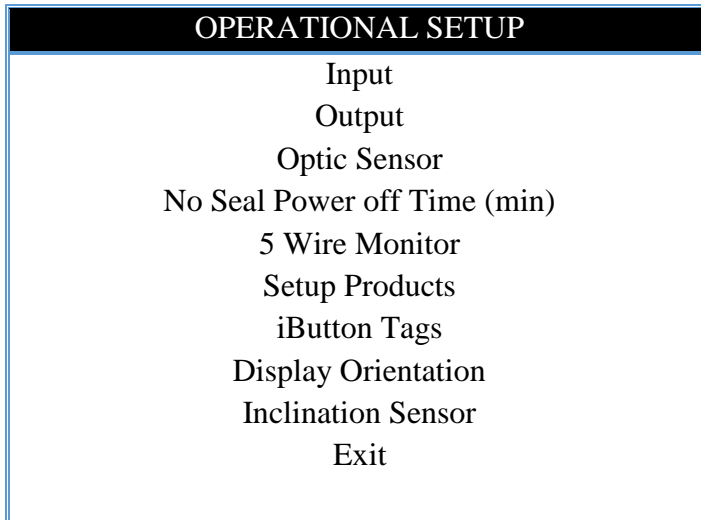

#### **1.4.1. Input**

When the 'Input' option is highlighted, the status will be shown at the bottom of the screen as Enabled or Disabled. To change the status, press 'ENT' with the option highlighted, then select the required status and press 'ENT' to set.

#### **1.4.2. Output**

When the 'Output' option is highlighted, the status will be shown at the bottom of the screen as Enabled or Disabled. To change the status, press 'ENT' with the option highlighted, then select the required status and press 'ENT' to set.

#### **1.4.3. Optic Sensor**

When the 'Optic Sensor' option is highlighted, the status will be shown at the bottom of the screen as Enabled or Disabled. To change the status, press 'ENT' with the option highlighted, then select the required status and press 'ENT' to set.

#### **1.4.4. No Seal Power off Time (min)**

To change the No Seal Power off Time, press 'ENT' with the option highlighted, then enter the required time and press 'ENT' to set.

#### **1.4.5. 5 Wire Monitor**

When the '5 Wire Monitor' option is highlighted, the status will be shown at the bottom of the screen as Enabled or Disabled. To change the status, press 'ENT' with the option highlighted, then select the required status and press 'ENT' to set.

### 1.4.6. Setup Products

When the 'Setup Products' option is selected, the 'Select Product' menu will be displayed:

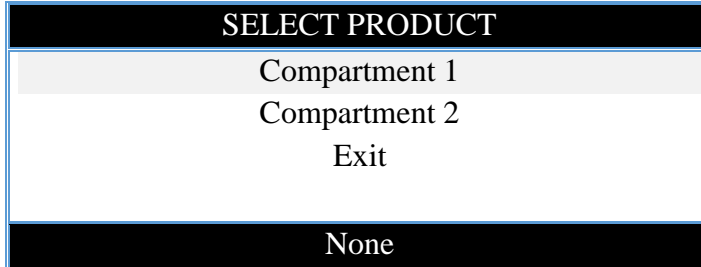

The number of compartments shown will depend on what was configured in the Facility Setup section. When a specific compartment is highlighted, the product that has been configured for that compartment will be shown at the bottom of the screen.

Select a compartment by pressing 'ENT' when the compartment is highlighted. This will display a list of products that can be set for the compartment:

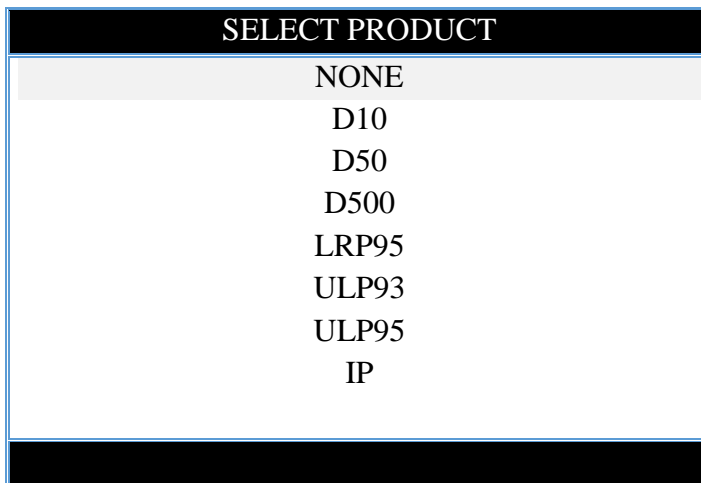

Select the product that is to be loaded into the compartment and press 'ENT'. Repeat the process for each compartment.

### 1.4.7. iButton Tags

When the 'iButton Tags' option is highlighted, the status will be shown at the bottom of the screen as Enabled or Disabled. To change the status, press 'ENT' with the option highlighted, then select the required status and press 'ENT' to set.



### 1.4.8. Display Orientation

When the ‘Display Orientation’ option is highlighted, the status will be shown at the bottom of the screen as Left or Right. To change the status, press ‘ENT’ with the option highlighted, then select the required status and press ‘ENT’ to set.

When ‘Left’ is set, the compartment numbering will be from the left to the right, while setting this option to ‘Right’ will show compartment 1 on the right-hand side of the screen with sequential numbers going to the left.

### 1.4.9. Inclination Sensor

When the ‘Inclination Sensor’ option is selected, the ‘Inclination Sensor Setup’ will be shown:

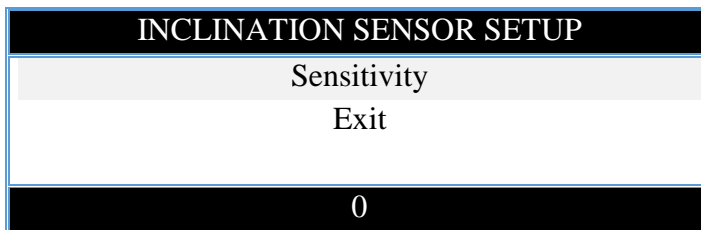

When the sensitivity option is highlighted, the sensitivity that has been set will be shown at the bottom of the screen.

Set the sensitivity by pressing ‘ENT’ when the sensitivity option is highlighted. Enter the required sensitivity and press ‘ENT’.

## 1.5. Test Routines

‘Test Routines’ is the fifth option on the ‘Main Menu’:

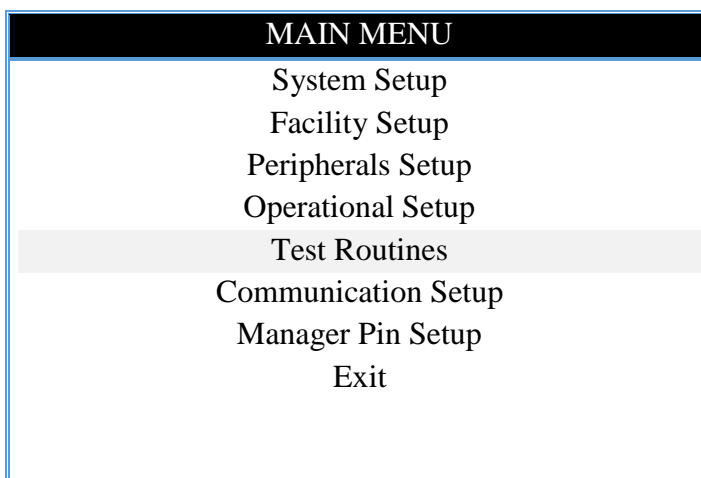

When the ‘Test Routines’ option is selected, the ‘Test Routines’ will be shown:

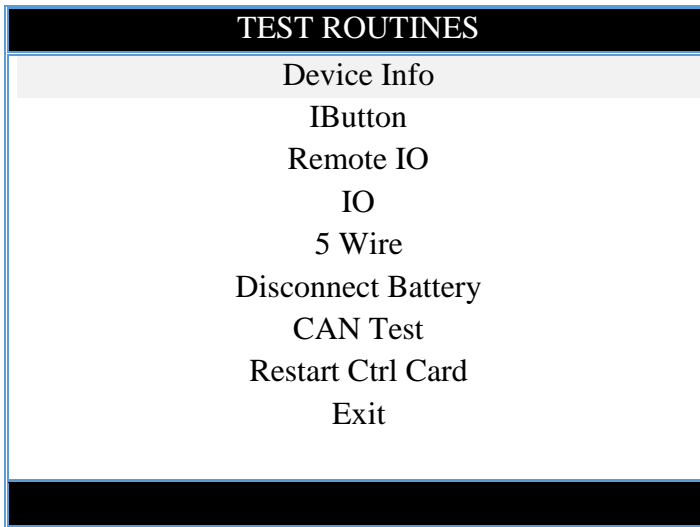

### 1.5.1. Device Info

When the 'Device Info' option is selected, the 'SCS System Info' menu is shown:

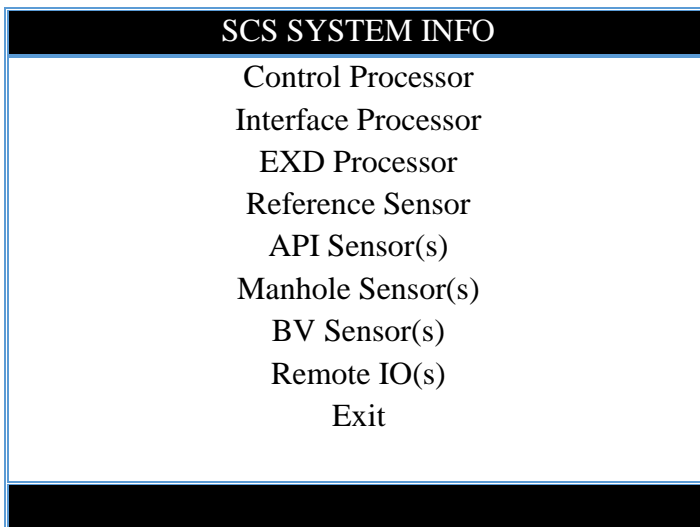

When any of the first four options are highlighted, the ID number for the component is shown at the bottom of the screen.

When API Sensor(s), Manhole Sensor(s) or BV Sensor(s) are selected and ‘ENT’ is pressed, the sensor info for the sensors will be displayed per compartment:

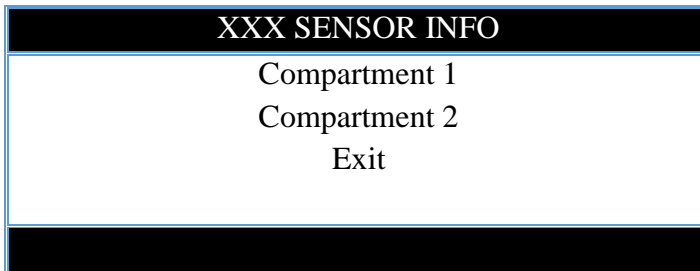

When a compartment is highlighted, the ID number for the sensor type in that compartment is shown at the bottom of the screen.

When Remote IO(s) is selected and ‘ENT’ is pressed, the ‘Remote IO Test’ is displayed:

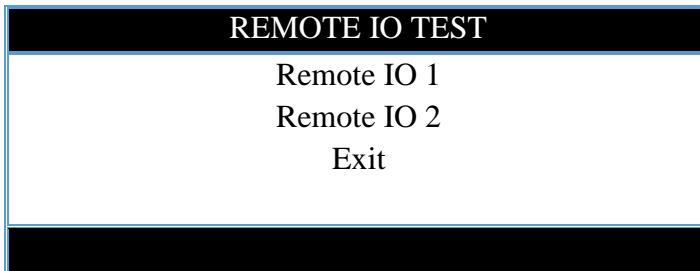

When an IO is highlighted, the ID number for the RemoteIO is shown at the bottom of the screen.

### 1.5.2. IButton

When the ‘IButton’ is highlighted and ‘ENT’ is pressed, the ‘IButton Tag Info’ is displayed:

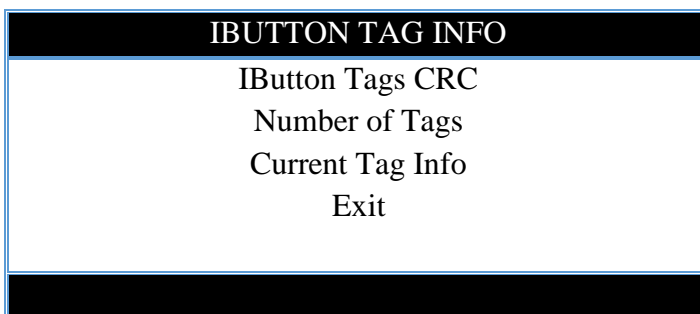

When either of the first two options is highlighted, the information for the component is shown at the bottom of the screen.

The ‘Current Tag Info’ will show the information associated with a tag when the tag is presented to the Tag Reader.

### 1.5.3. Remote IO

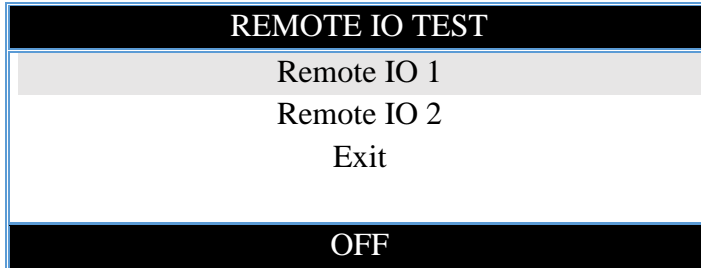

While a specific ‘Remote IO X’ option is highlighted, its status (On / Off) will be shown at the bottom of the screen.

### 1.5.4. IO

When the ‘IO’ menu option is highlighted and ‘ENT’ is pressed, the ‘Test IO’ menu is displayed:

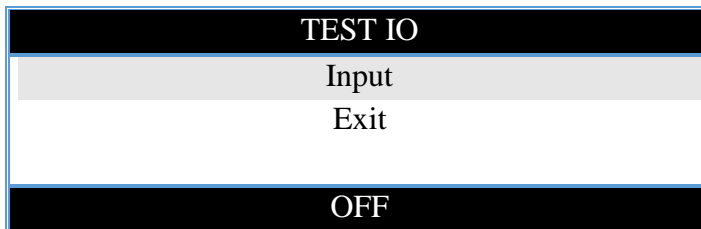

While the ‘Input’ option is highlighted, the status (On / Off) will be shown at the bottom of the screen.

### 1.5.5. 5 Wire

When the ‘5 Wire’ menu option is highlighted and ‘ENT’ is pressed, the ‘5 Wire Info’ menu is displayed:

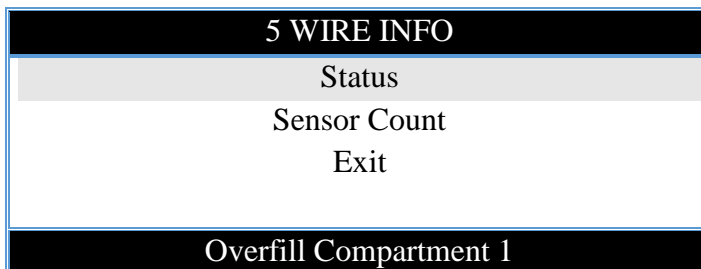

While either option is highlighted, the status will be shown at the bottom of the screen.

### 1.5.6. Disconnect Battery

With the 'Disconnect Battery' menu option highlighted, pressing the 'ENT' key will bring up the confirmation display:

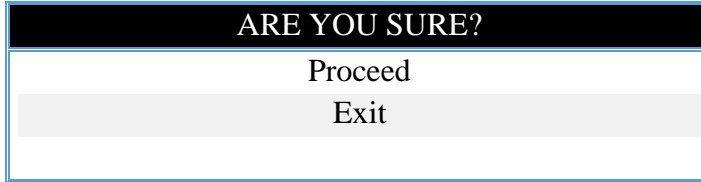

If you select 'Proceed' and press 'ENT', the battery will be disconnected.

### 1.5.7. CAN Test

With the 'CAN Test' menu option highlighted, pressing the 'ENT' key will bring up the 'CAN Bus' menu:

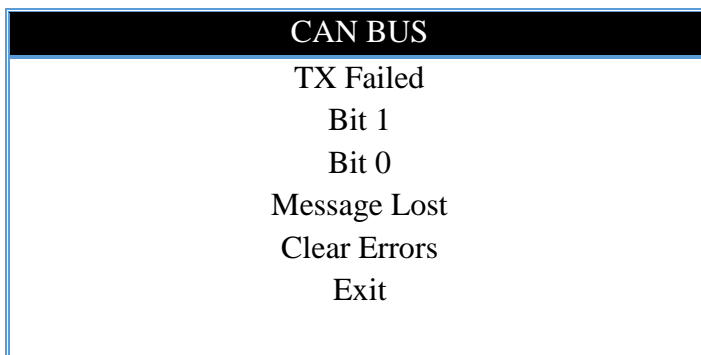

Highlighting any of the first 4 options will show the error count for that option at the bottom of the screen. Selecting the 'Clear Errors' option and pressing 'ENT' will reset all the error counters to 0.

### 1.5.8. Restart Ctrl Card

With the 'Restart Ctrl Card' menu option highlighted, pressing the 'ENT' key will bring up the confirmation display:

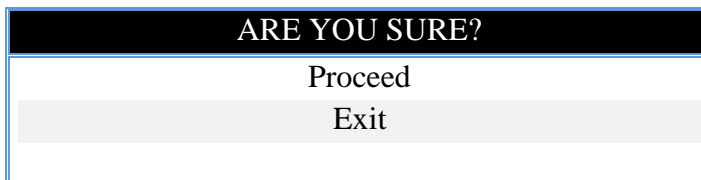

If you select 'Proceed' and press 'ENT', the control card will be reset.

## 1.6. Communication Setup

The 'Communication Setup' is the sixth option on the 'Main Menu':

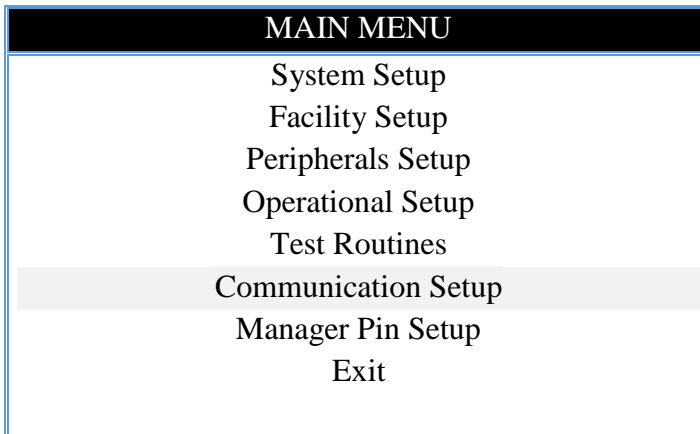

With the 'Communication Setup' menu option highlighted, pressing the 'ENT' key will bring up the 'Communication Setup' menu:

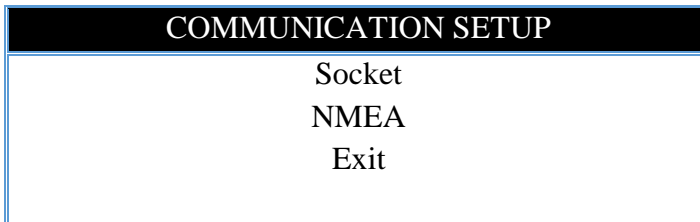

Selecting the 'Socket' option and pressing 'ENT' will display the 'Socket Setup' menu:

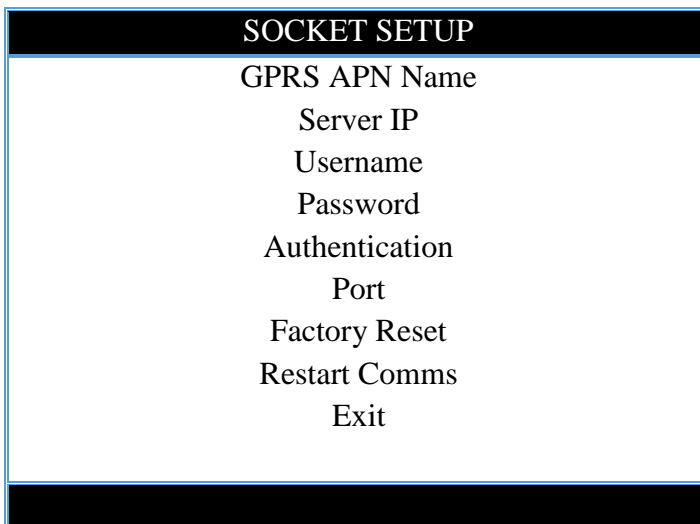

Highlighting any option will display the current configuration for that option at the bottom of the screen.

Pressing 'ENT' with an option highlighted will bring up the confirmation display:

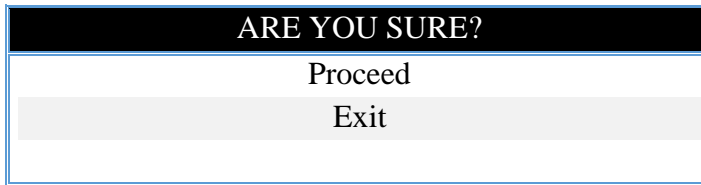

Selecting the 'Proceed' option and pressing 'ENT' will allow the changing of the setting.

### 1.7. Manager Pin Setup

The 'Manager Pin Setup' is the seventh option on the 'Main Menu':



With the 'Manager Pin Setup' menu option highlighted, pressing the 'ENT' key will bring up the 'Pin Manager' menu:



Selecting the 'Enter Pin option and pressing 'ENT' will display the 'Pin Manager' menu:



With any of the PINs highlighted, the current value of that PIN will be shown at the bottom of the screen. Press 'ENT' with a PIN highlighted to change the PIN.

30 PINs can be set. Use the 'RIGHT' and 'LEFT' arrows to move to the next and previous page of PIN numbers.

Highlighting either the 'Set Limit' or the 'Reset Limit' option on the main 'PIN Manager' menu will allow changing of the relevant parameter.